



# PROPHET™ PRECEPT™ 80W LCD AC/DC MULTI-CHEMISTRY BATTERY CHARGER

INSTRUCTION MANUAL | BEDIENUNGSANLEITUNG | MANUEL D'UTILISATION | MANUALE DI ISTRUZIONI

(DYNC2015)

## ENGLISH

### NOTICE

All instructions, warranties and other collateral documents are subject to change at the sole discretion of Horizon Hobby, LLC. For up-to-date product literature, visit horizonhobby.com and click on the support tab for this product.

### Meaning of Special Language

The following terms are used throughout the product literature to indicate various levels of potential harm when operating this product:

**NOTICE:** Procedures, which if not properly followed, create a possibility of physical property damage AND a little or no possibility of injury.

**CAUTION:** Procedures, which if not properly followed, create the probability of physical property damage AND a possibility of serious injury.

**WARNING:** Procedures, which if not properly followed, create the probability of property damage, collateral damage, and serious injury OR create a high probability of superficial injury.

**WARNING:** Read the ENTIRE instruction manual to become familiar with the features of the product before operating. Failure to operate the product correctly can result in damage to the product, personal property and cause serious injury.

This is a sophisticated hobby product. It must be operated with caution and common sense and requires some basic mechanical ability. Failure to operate this Product in a safe and responsible manner could result in injury or damage to the product or other property. This product is not intended for use by children without direct adult supervision. Do not attempt disassembly, use with incompatible components or alignment product in any way without the approval of Horizon Hobby, LLC. This manual contains instructions for safety, operation and maintenance. It is essential to read and follow all the instructions and warnings in the manual, prior to assembly, setup or use, in order to operate correctly and avoid damage or serious injury.

### Age Recommendation: Not for children under 14 years. This is not a toy.

This appliance is not intended for use by persons with reduced physical, sensory or mental capabilities, or lack of experience and knowledge, unless they have been given supervision or instruction concerning use of the appliance by a person responsible for their safety.

### Included Items:

- JST\_XH Balance adapter
- Banana plug to EC3™ battery connector
- AC power cord (one region-US, EU, AU or UK)

### OPTIONAL ACCESSORIES

- DYN4012 - DC Power Cord
- DYN5006 - Charge Adapter Banana to Deans Male
- DYN5014 - Charge Adapter: Banana to Traxxas® Male
- DYN5033 - Temperature Sensor

### SAFETY PRECAUTIONS AND WARNINGS

**WARNING:** Failure to exercise caution while using this product and comply with the following warnings could result in product malfunction, electrical issues, excessive heat, FIRE, and ultimately injury and property damage.

- Never leave the power supply, charger and battery unattended during use.
- Never attempt to charge dead, damaged or wet battery packs.
- Never attempt to charge a battery pack containing different types of batteries.
- Never allow children under 14 years of age to charge battery packs.
- Never charge batteries in extremely hot or cold places or place in direct sunlight.
- Never charge a battery if the cable has been pinched or shorted.
- Never connect the charger if the power cable has been pinched or shorted.
- Never connect the charger to an automobile 12V battery while the vehicle is running.
- Never attempt to dismantle the charger or use a damaged charger.
- Never attach your charger to both an AC and a DC power source at the same time.
- Never connect the input jack (DC input) to AC power.
- Always use only rechargeable batteries designed for use with this type of charger.
- Always inspect the battery before charging.
- Always keep the battery away from any material that could be affected by heat.
- Always monitor the charging area and have a fire extinguisher available at all times.
- Always end the charging process if the battery becomes hot to the touch or starts to change form (swell) during the charge process.
- Always connect the charge cable to the charger first, then connect the battery to avoid short circuit between the charge leads. Reverse the sequence when disconnecting.
- Always connect the positive red (+) and negative black leads (-) correctly.
- Always disconnect the battery after charging, and let the charger cool between charges.
- Always charge in a well-ventilated area.
- Always terminate all processes and contact Horizon Hobby if the product malfunctions.

**WARNING:** Never leave charger unattended, exceed maximum charge rate, charge with non-approved batteries or charge batteries in the wrong mode. Failure to comply may result in excessive heat, fire and serious injury.

**CAUTION:** Always ensure the battery you are charging meets the specifications of this charger and that the charger settings are correct. Not doing so can result in excessive heat and other related product malfunctions, which can lead to user injury or property damage. Please contact Horizon Hobby or an authorized retailer with compatibility questions.

### SPECIFICATIONS

AC Input Voltage	100–240V AC (50–60Hz)
DC Input Voltage	11–18V DC
Charge Current	0.1A to 6.0A (in 0.1A increments/80W maximum)
Discharge Current	0.10 to 2.0A (in 0.1A increments/10W maximum)
Operating Temperature	0° C to + 50° C
Balance Current Drain	300mA per cell
Charging Mode	Ni-Cd/Ni-MH; PE; Li-Po/Li-Ion/Li-Fe/Pb; CC/CV

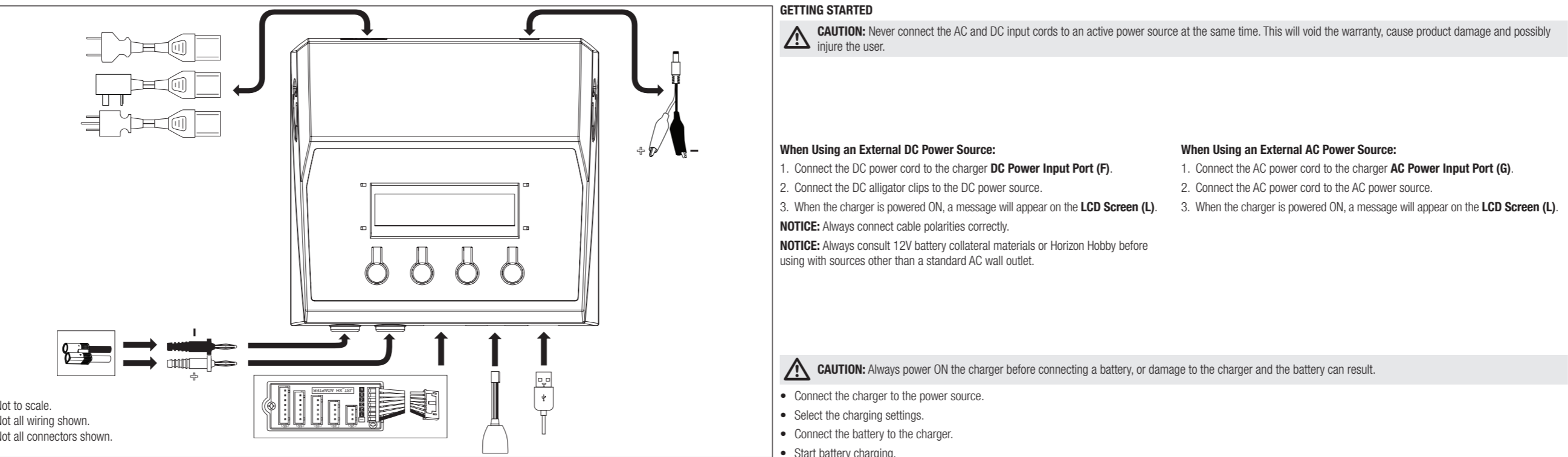
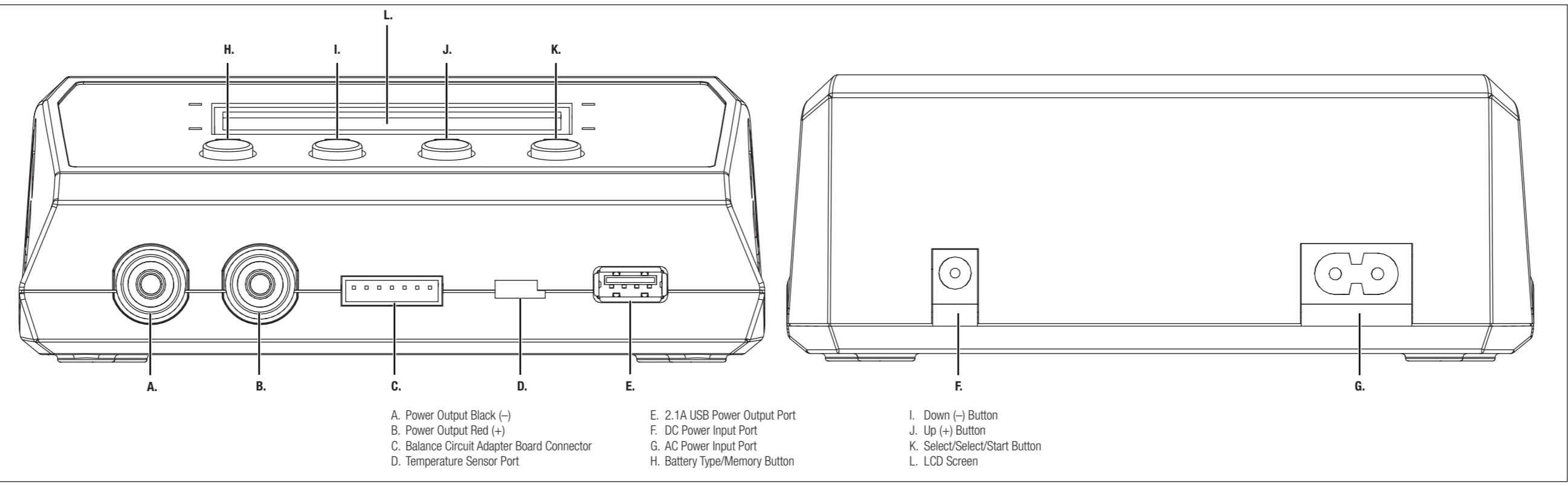

## OPERATING YOUR CHARGER

<b>1 SELF TEST AND PROGRAM SELECT SCREENS</b>	<b>12 NICKEL-CADMIUM (NI-Cd) BATTERIES</b>	<b>21 PROGRAM SELECT USER SET</b>
<b>LITHIUM</b>	<b>Ni-Cd</b>	<b>a LITHIUM BATTERY TYPE</b>
2 LITHIUM BATTERIES	13 NI-CD CHARGING	<b>b LITHIUM BATTERY CHECK TIME</b>
3 LITHIUM CHARGING	14 NI-CD DISCHARGING	<b>c NI-MH SENSITIVITY (PEAK VOLTAGE)</b>
4 LITHIUM BALANCING CHARGING	15 NI-CD CYCLE CHARGING	<b>d NI-CD SENSITIVITY (PEAK VOLTAGE)</b>
5 LITHIUM FAST CHARGING	<b>Pb</b>	<b>e BATTERY CUTOFF TEMPERATURE</b>
6 LITHIUM STORAGE CHARGING	16 LEAD-ACID/SEALED-LEAD-ACID (Pb) BATTERIES	<b>f WASTE (BATTERY COOL-DOWN) TIME</b>
7 LITHIUM DISCHARGING	17 Pb CHARGING	<b>g SAFETY TIMER</b>
<b>NI-MH</b>	18 Pb DISCHARGING	<b>h BATTERY CAPACITY CUTOFF</b>
8 NICKEL-METAL HYDRIDE (NI-MH) BATTERIES	<b>USER SETTINGS</b>	<b>i BEEP AND BUZZER SOUND CONTROL</b>
9 NI-MH CHARGING	19 SAVE DATA	<b>j INPUT POWER LOW VOLTAGE CUTOFF</b>
10 NI-MH DISCHARGING	20 LOAD DATA	<b>k USB DEVICE CHARGING</b>
11 NI-MH CYCLE CHARGING		<b>23 TROUBLESHOOTING</b>

### 1 SELF TEST AND PROGRAM SELECT SCREENS

When the charger is powered ON, there is a series of self tests and the screen will show the charger brand name and model number.

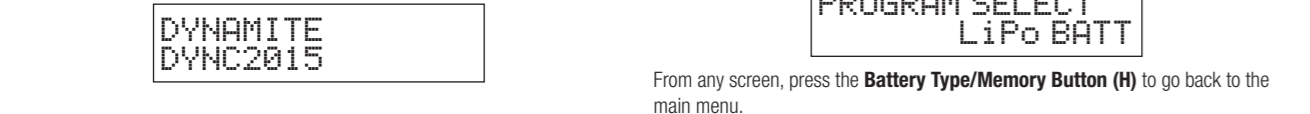

From any screen, press the **Battery Type/Memory Button (H)** to go back to the main menu.

### 2 LITHIUM BATTERIES

Press the **Battery Type/Memory Button (H)** to change among the 7 main menu screens and go to the PROGRAM SELECT Lithium BATT screen. Press the **Select/Start Button (K)** to enter this menu. This is the menu in which you set the standard Lithium battery charge parameters.

The Lithium battery type (Li-Po, Li-Ion or Li-Fe) chosen at USER SET setup shows on this screen. Charge Lithium battery type as needed in the USER SET menu (LiV TYPE screen). Change other Lithium battery settings as needed in the USER SET menu. Refer to the PROGRAM SELECT USER SET screen.



Press the **Down (-) Button (I)** or **Up (+) Button (J)** to go to one of the control screens (CHARGE, BALANCE, FAST CHG, STORAGE or DISCHARGE) to do what your battery needs. Correctly connect your lithium battery to the charger (charging connector first and balancing connector second). Press the **Select/Start Button (K)** and adjust charging parameters as needed. Press and hold the **Select/Start Button** (approximately 3 seconds) until the screen changes to start the battery check/charge sequence. When the charge cycle starts, the charger compares the battery to charger settings. The screen will show battery and your settings information.

If the information after R: (charger) and S: (settings) (A) does not match, press the **Battery Type/Memory Button** and change the lithium battery charging parameters as needed. If the R: information matches S:, press the **Select/Start Button** to confirm. After confirmation, charging starts and information will show on the LCD screen.



During charging, the **Down (-) Button** can be pressed to show several parameter messages on the LCD screen including: End Voltage, Capacity Cut-off, Safety Timer setting, Temperature Cut-off, External Temperature and Input Power Voltage. Press the **Up (+) Button** to see charge voltages for each cell and the **Down (-) Button** to return to the Charge Monitor screen. To change the charging rate during charging, press the **Select/Start Button**, then increase or decrease the rate using the **Down (-) Button** and **Up (+) Button**. The charger signals when the charging (or discharging) process is complete (if buzzer is set to ON).

Press the **Battery Type/Memory Button** at any time to stop charging (or discharging).

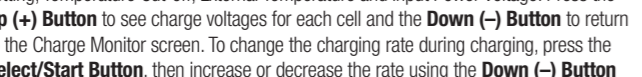

**CAUTION:** If at any time during the charge process the battery pack(s) become hot or begin to puff disconnect the battery immediately and discontinue the charge process as batteries can cause fire, collateral damage and injuries.

**CAUTION:** Using a charge rate that is not compatible with the battery capacity may result in damage or malfunction of the charger or battery.

**CAUTION:** The Lithium charge program menus are to be used ONLY for the charging and discharging of Lithium battery packs. Charging other battery types using the Lithium charge programs will damage the battery or the charger.

### 3 LITHIUM CHARGING

Press the **Battery Type/Memory Button (H)** until you reach the 7 main menu. Then press the **Battery Type/Memory Button** until you reach the PROGRAM SELECT Lithium BATT screen. Press the **Select/Start Button (K)** to enter this menu.

Press the **Down (-) Button (I)** or **Up (+) Button (J)** to reach the CHARGE screen and set charging parameters. The charging amperage (A) can be set between 0.1 and 6.0A. Voltage (C) is dependent on the number of cells in series (B) and Lithium battery type.

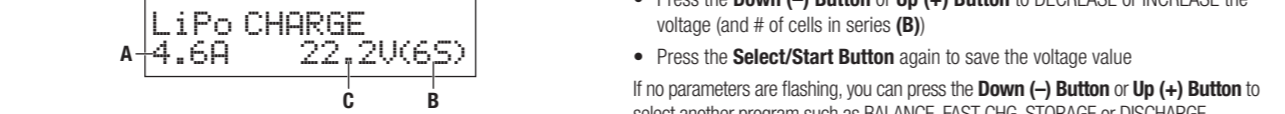

- To select values other than the existing parameters:
- Press the **Select/Start Button** so the charge current value (A) flashes.
  - Press the **Down (-) Button** or **Up (+) Button** to DECREASE or INCREASE the charge current value.
  - Press the **Select/Start Button** again to save the value and the voltage value (C) flashes.
  - Press the **Down (-) Button** or **Up (+) Button** to DECREASE or INCREASE the voltage (and # of cells in series) (B).
  - Press the **Select/Start Button** again to save the voltage value.

If no parameters are flashing, you can press the **Down (-) Button** or **Up (+) Button** to select another program such as BALANCE, FAST CHG, STORAGE or DISCHARGE. To start charging, press and hold the **Select/Start Button** for 3 seconds.

### 4 LITHIUM BALANCING CHARGING

This program menu is specifically designed for the balanced charging of Lithium batteries, including Li-Po, Li-Fe and Li-Ion battery packs. In balance charging, each cell in the battery pack is monitored and charged to the same capacity and voltage levels, ensuring the optimum performance of the pack. Balance charging requires a battery with a balance adapter connector and a balance adapter board that has been designed for your charger and your battery.

Press the **Battery Type/Memory Button (H)** until you reach the 7 main menu. Then press the **Battery Type/Memory Button** until you reach the PROGRAM SELECT Lithium BATT screen. Press the **Select/Start Button (K)** to enter this menu.

Press the **Down (-) Button (I)** or **Up (+) Button (J)** to reach the BALANCE screen and set charging parameters. The charging amperage (A) can be set between 0.1 and 6.0A. Voltage (C) is dependent on the number of cells in series (B).

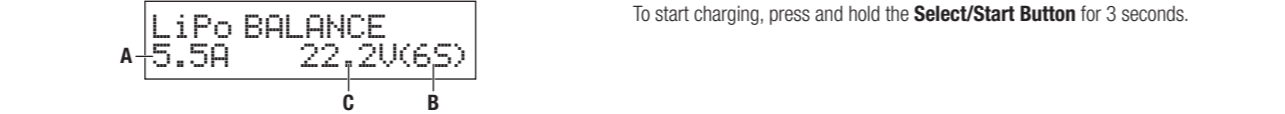

- To select values other than the existing parameters:
- Press the **Select/Start Button** so the charge current value (A) flashes.
  - Press the **Down (-) Button** or **Up (+) Button** to DECREASE or INCREASE the charge current value.
  - Press the **Select/Start Button** again to save the value and the voltage value (C) flashes.
  - Press the **Down (-) Button** or **Up (+) Button** to DECREASE or INCREASE the voltage (and # of cells in series) (B).
  - Press the **Select/Start Button** again to save the voltage value.
- If no parameters are flashing, you can press the **Down (-) Button** or **Up (+) Button** to select another program such as CHARGE, FAST CHG, STORAGE or DISCHARGE. To start charging, press and hold the **Select/Start Button** for 3 seconds.

### 5 LITHIUM FAST CHARGING

Near the end of a standard charging cycle the charger switches from Constant Current (CC) mode to Constant Voltage (CV) mode to slowly "top off" the current in the battery pack as close as possible to the maximum capacity. In Fast Charge, the CV mode is eliminated in order to greatly shorten the charging time; however, the final capacity of the battery will be less than what you would get using the standard charge method.

Press the **Battery Type/Memory Button (H)** until you reach the 7 main menu. Then press the **Battery Type/Memory Button** until you reach the PROGRAM SELECT Lithium BATT screen. Press the **Select/Start Button (K)** to enter this menu.

Press the **Down (-) Button (I)** or **Up (+) Button (J)** to reach the FAST CHG screen and set charging parameters.

The charging amperage (A) can be set between 0.1 and 6.0A. Voltage (C) is dependent on the number of cells in series (B).

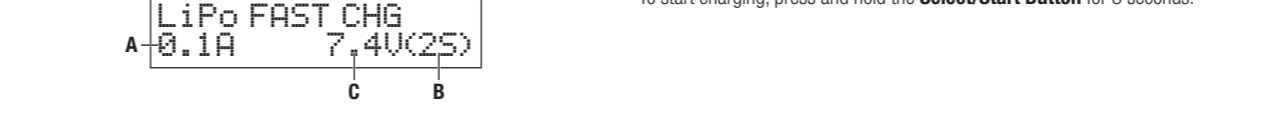

- To select values other than the existing parameters:
- Press the **Select/Start Button** so the charge current value (A) flashes.
  - Press the **Down (-) Button** or **Up (+) Button** to DECREASE or INCREASE the charge current value.
  - Press the **Select/Start Button** again to save the value and the voltage value (C) flashes.
  - Press the **Down (-) Button** or **Up (+) Button** to DECREASE or INCREASE the voltage (and # of cells in series) (B).
  - Press the **Select/Start Button** again to save the voltage value.

### 6 LITHIUM STORAGE CHARGING

If you don't plan on using your battery for a long time it is best to charge (or discharge) the battery to its optimal storage voltage and capacity. These storage voltages are different for Li-Po (3.85V), Li-Fe (3.3V) and Li-Ion (3.75V) battery packs. Using Storage Charging, the charger will automatically charge or discharge (depending on the current charge level) the battery to an appropriate level.

Press the **Battery Type/Memory Button (H)** until you reach the 7 main menu. Then press the **Battery Type/Memory Button** until you reach the PROGRAM SELECT Lithium BATT screen. Press the **Select/Start Button (K)** to enter this menu.

Press the **Down (-) Button (I)** or **Up (+) Button (J)** to reach the STORAGE screen and set charging parameters.

The charging amperage (A) can be set between 0.1 and 6.0A. Voltage (C) is dependent on the number of cells in series (B).

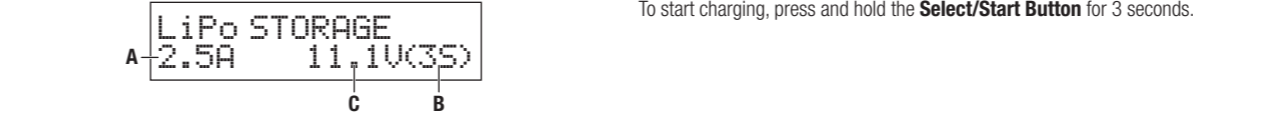

- To select values other than the existing parameters:
- Press the **Select/Start Button** so the charge current value (A) flashes.
  - Press the **Down (-) Button** or **Up (+) Button** to DECREASE or INCREASE the charge current value.
  - Press the **Select/Start Button** again to save the value and the voltage value (C) flashes.
  - Press the **Down (-) Button** or **Up (+) Button** to DECREASE or INCREASE the voltage (and # of cells in series) (B).
  - Press the **Select/Start Button** again to save the voltage value.

### 7 LITHIUM DISCHARGING

A battery pack's capacity can be verified by discharging the pack to its minimum voltage level and measuring the current as the pack is discharged.

Press the **Battery Type/Memory Button (H)** until you reach the 7 main menu. Then press the **Battery Type/Memory Button** until you reach the PROGRAM SELECT Lithium BATT screen. Press the **Select/Start Button (K)** to enter this menu.

Press the **Down (-) Button (I)** or **Up (+) Button (J)** to reach the DISCHARGE screen and set discharging parameters.

The discharging amperage (A) can be set between 0.1 and 2.0A. Voltage (C) is dependent on the number of cells in series (B).

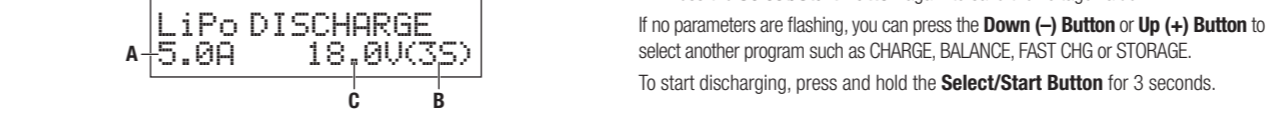

- To select values other than the existing parameters:
- Press the **Select/Start Button** so the discharge current value (A) flashes.
  - Press the **Down (-) Button** or **Up (+) Button** to DECREASE or INCREASE the discharge current value.
  - Press the **Select/Start Button** again to save the value and the voltage value (C) flashes.
  - Press the **Down (-) Button** or **Up (+) Button** to DECREASE or INCREASE the voltage (and # of cells in series) (B).
  - Press the **Select/Start Button** again to save the voltage value.

If no parameters are flashing, you can press the **Down (-) Button** or **Up (+) Button** to select another program such as CHARGE, BALANCE, FAST CHG or STORAGE. To start discharging, press and hold the **Select/Start Button** for 3 seconds.

### PROGRAMMING QUICK GUIDE

Press the **Battery Type/Memory Button (H)** to change among main menu screens or to get to these main menu screens from a submenu screen. Press the **Select/Start Button (K)** to get to submenus for adjusting operating parameters, to save value changes, or to start chosen battery charging actions. Press the **Decrease (I)** or **Up (+) Buttons (J)** to change between submenu screens or to change (Decrease or Increase) screen values.

### LITHIUM BATTERIES (LI-PO)

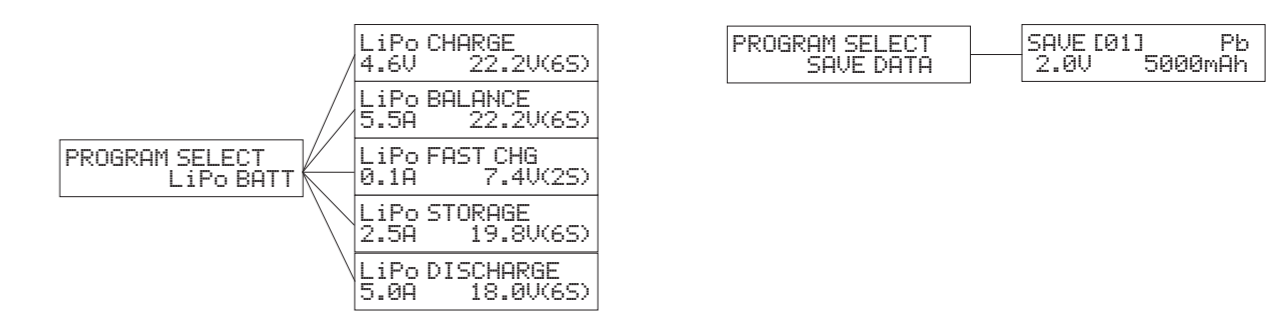

### SAVE DATA

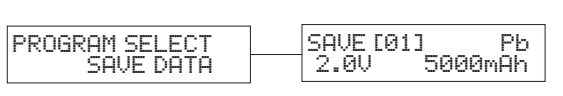

### NI-MH BATTERIES

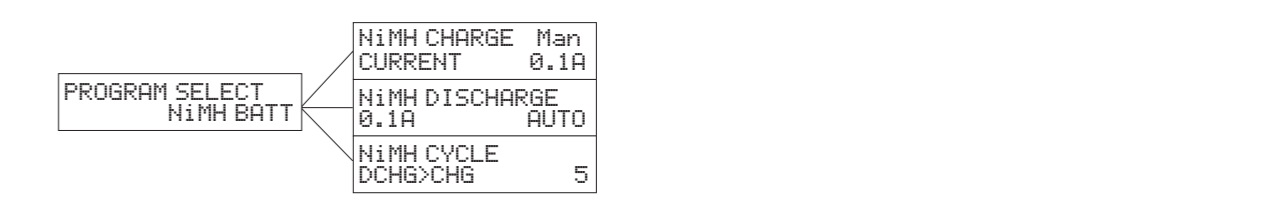

### LOAD DATA



### NI-Cd BATTERIES

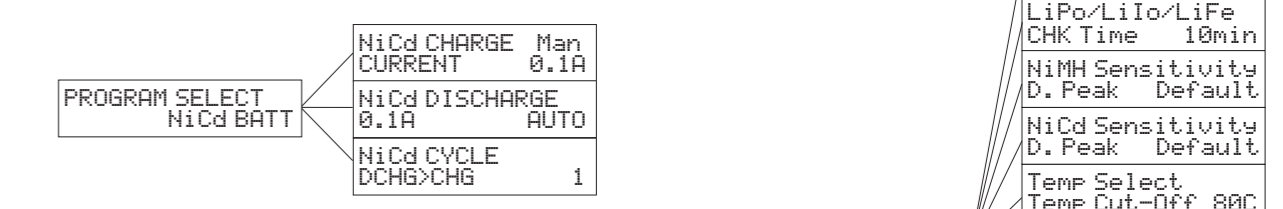

### USER SET

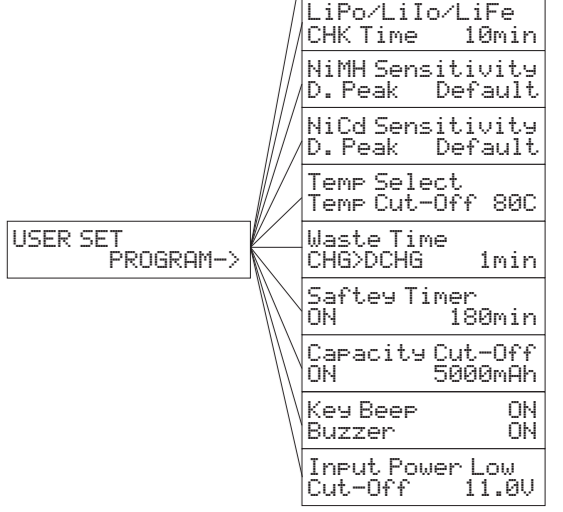

### Pb BATTERIES

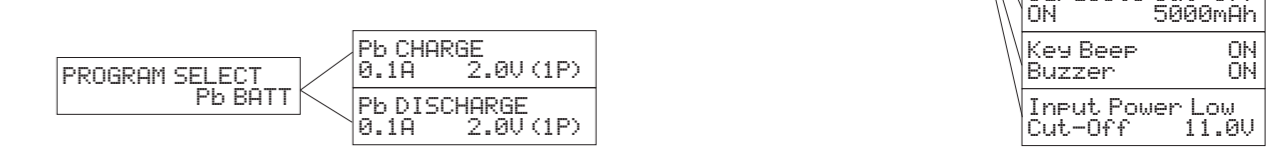

### 8 NICKEL-METAL HYDRIDE (NI-MH) BATTERIES

Press the **Battery Type/Memory Button (H)** to change among the 7 main menu screens and go to PROGRAM SELECT Ni-MH BATT screen. Press the **Select/Start Button (K)** to enter this menu. This is the menu in which you set the standard Ni-MH battery charge parameters.

Change other Ni-MH battery settings as needed in the USER SET menu. Refer to the PROGRAM SELECT USER SET screen.

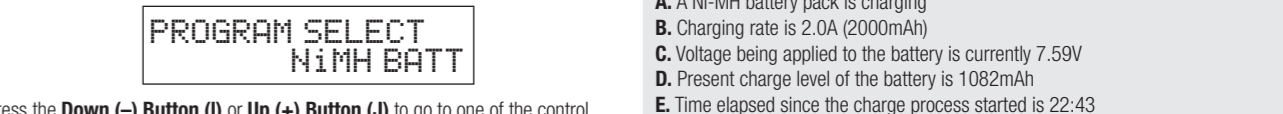

Press the **Down (-) Button (I)** or **Up (+) Button (J)** to go to one of the control screens (CHARGE, DISCHARGE or CYCLE) to do what your battery needs. Correctly connect your Ni-MH battery to the charger. Press the **Select/Start Button (K)** and adjust charging parameters as needed. Press and hold the **Select/Start Button** (approximately 3 seconds) until the screen changes to start the battery check/charge sequence. After confirmation, charging starts and information will show on the LCD screen.

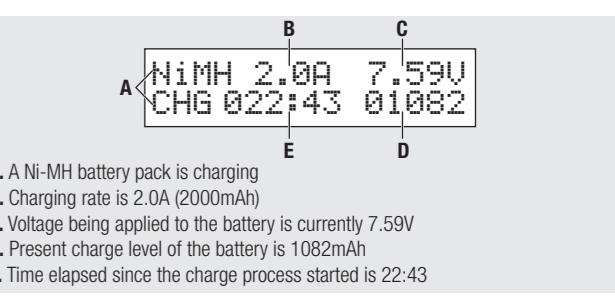

**CAUTION:** The Ni-MH charge program menus are to be used ONLY for the charging and discharging of Ni-MH battery packs. Charging other battery types using the Ni-MH charge programs will damage the battery or the charger.

### 9 NI-MH CHARGING

Press the **Battery Type/Memory Button (H)** until you reach the 7 main menu. Then press the **Battery Type/Memory Button** until you reach the PROGRAM SELECT NiMH BATT screen. Press the **Select/Start Button (K)** to enter this menu.

Press the **Down (-) Button (I)** or **Up (+) Button (J)** to reach the NiMH CHARGE screen and set charging parameters. The charging amperage (A) can be set between 0.1 and 6.0A.

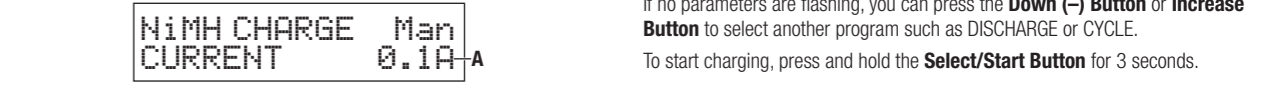

- To select a value other than the existing parameter:
- Press the **Select/Start Button** so the charge current value (A) flashes.
  - Press the **Down (-) Button** or **Up (+) Button** to DECREASE or INCREASE the charge current value.
  - Press the **Select/Start Button** again to save the value.

If no parameters are flashing, you can press the **Down (-) Button** or **Increase Button** to select another program such as CHARGE or CYCLE. To start charging, press and hold the **Select/Start Button** for 3 seconds.

### 10 NI-MH DISCHARGING

A battery pack's capacity can be verified by discharging the pack to its minimum voltage level and measuring the current as the pack is discharged.

Press the **Battery Type/Memory Button (H)** until you reach the 7 main menu. Then press the **Battery Type/Memory Button** until you reach the PROGRAM SELECT NiMH BATT screen. Press the **Select/Start Button (K)** to enter this menu.

Press the **Down (-) Button (I)** or **Up (+) Button (J)** to reach the NiMH DISCHARGE screen and set discharging parameters. The discharging amperage (A) can be set between 0.1 and 2.0A. The discharge level (B) can be set for AUTO or from 0.1 to 25.0V.

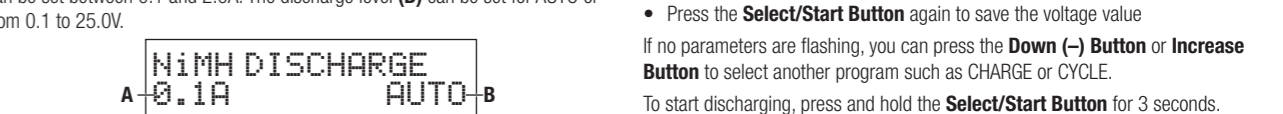

- To select values other than the existing parameters:
- Press the **Select/Start Button** so the discharge current value (A) flashes.
  - Press the **Down (-) Button** or

## 12 NICKEL-CADMIUM (NI-CD) BATTERIES

Press the **Battery Type/Memory Button (H)** to change among the 7 main menu screens and go to the PROGRAM SELECT Ni-Cd BATT screen. Press the **Select/Start Button (K)** to enter this menu. This is the menu in which you set the standard Ni-Cd battery charge parameters.

PROGRAM SELECT  
NiCd BATT

Change other Ni-Cd battery charging settings as needed in the USER SET menu. Refer to the PROGRAM SELECT USER SET screen.

Press the **Down (-) Button (I)** or **Up (+) Button (J)** to go to one of the control screens (CHARGE, DISCHARGE or CYCLE) to do what your battery needs. Correctly connect your Ni-Cd battery to the charger. Press the **Select/Start Button (K)** and adjust charging parameters as needed. Press and hold the **Select/Start Button** (approximately 3 seconds) until the screen changes to start the battery check/charge sequence. After confirmation, charging starts and information will show on the LCD screen.

**CAUTION:** The Ni-Cd charge program menus are to be used ONLY for the charging and discharging of Ni-Cd battery packs. Charging other battery types using the Ni-Cd charge programs will damage the battery or the charger.

## 13 NI-CD CHARGING

Press the **Battery Type/Memory Button (H)** until you reach the 7 main menus. Then press the **Battery Type/Memory Button** until you reach the PROGRAM SELECT NiCd BATT screen. Press the **Select/Start Button (K)** to enter this menu. Press the **Down (-) Button (I)** or **Up (+) Button (J)** to reach the NiCd CHARGE screen and set charging parameters. The charging amperage (A) can be set between 0.1 and 6.0A.

NiCd CHARGE Man  
CURRENT 0.1A

## 14 NI-CD DISCHARGING

A battery pack's capacity can be verified by discharging the pack to its minimum voltage level and measuring the current as the pack is discharged.

Press the **Battery Type/Memory Button (H)** until you reach the 7 main menus. Then press the **Battery Type/Memory Button** until you reach the PROGRAM SELECT NiCd BATT screen. Press the **Select/Start Button (K)** to enter this menu. Press the **Down (-) Button (I)** or **Up (+) Button (J)** to reach the NiCd DISCHARGE screen and set discharging parameters. The discharging amperage (A) can be set between 0.1 and 2.0A. The discharge level (B) can be set for AUTO or from 0.1 to 25.0V.

NiCd DISCHARGE  
A 0.1A B AUTO

## 15 NI-CD CYCLE CHARGING

The battery can be put through a series of charge/discharge cycles using this program. Cycling Ni-Cd batteries can increase capacity and rejuvenate neglected batteries. Discharge capacity and average battery voltage help you compare batteries for the best run time and power.

Press the **Battery Type/Memory Button (H)** until you reach the 7 main menus. Then press the **Battery Type/Memory Button** until you reach the PROGRAM SELECT NiCd BATT screen. Press the **Select/Start Button (K)** to enter this menu. Press the **Down (-) Button (I)** or **Up (+) Button (J)** to reach the NiCd CYCLE screen and set charge/discharge cycle count parameters.

NiCd CYCLE  
A <DCHG>CHG B 5

## 16 LEAD-ACID/SEALED-LEAD-ACID (PB) BATTERIES

Press the **Battery Type/Memory Button (H)** to change among the 7 main menu screens and go to the PROGRAM SELECT Pb BATT screen. Press the **Select/Start Button (K)** to enter this menu. This is the menu in which you set the standard Pb battery charge parameters.

PROGRAM SELECT  
Pb BATT

The nature of a Lead-Acid or Sealed-Lead-Acid battery is very different from that of Lithium, Ni-MH or Ni-Cd batteries. The output current of a Pb battery is lower than other batteries relative to their capacities. Furthermore, lead-acid batteries can't be charged at a level greater than 1/10 their capacity. For example, a 5000mAh lead acid battery can't be charged at a rate greater than 0.5A. For more details on the charge and discharge capabilities of your battery, please refer to the charging data supplied by the battery manufacturer.

Press the **Down (-) Button (I)** or **Up (+) Button (J)** to go to one of the control screens (CHARGE or DISCHARGE) to do what your battery needs. Correctly connect your Pb battery to the charger. Press the **Select/Start Button (K)** and adjust charging parameters as needed. Press and hold the **Select/Start Button** (approximately 3 seconds) until the screen changes to start the battery check/charge sequence. After confirmation, charging starts and information will show on the LCD screen.

**CAUTION:** The Pb charge program menus are to be used ONLY for the charging and discharging of Pb battery packs. Charging other battery types using the Pb charge programs will damage the battery or the charger.

## 17 PB CHARGING

Press the **Battery Type/Memory Button (H)** until you reach the 7 main menus. Then press the **Battery Type/Memory Button** until you reach the PROGRAM SELECT Pb BATT screen. Press the **Select/Start Button (K)** to enter this menu. Press the **Down (-) Button (I)** or **Up (+) Button (J)** to reach the Pb CHARGE screen and set charging parameters. The charging amperage (A) can be set between 0.1 and 6.0A. Voltage (C) is dependent on the number of cells in series (B) and can be set between 2.0 (for 1P batteries) to 20.0V (for 10P batteries).

Pb CHARGE  
A 0.1A B C 2.0V(1P) B

A B C  
NiCd 2.0A 7.59V  
CHG 022:43 01082  
E D

A. A Ni-Cd battery pack is charging  
B. Charging rate is 2.0A (2000mA)  
C. Voltage being applied to the battery is currently 7.59V  
D. Present charge level of the battery is 1082mAh  
E. Time elapsed since the charge process started is 22:43

During charging, the **Down (-) Button** or **Up (+) Button** can be pressed to show several parameter messages on the LCD screen including: Ni-Cd Sensitivity, Capacity Cut-off, Safety Timer setting, Temperature Cut-off, External Temperature and Input Power Voltage. The charger signals when the charging (or discharging) process is complete (if Buzzer is set to ON).

Press the **Battery Type/Memory Button** at any time to stop charging (or discharging).

**CAUTION:** The Ni-Cd charge program menus are to be used ONLY for the charging and discharging of Ni-Cd battery packs. Charging other battery types using the Ni-Cd charge programs will damage the battery or the charger.

## 18 NI-CD CHARGING

Press the **Battery Type/Memory Button (H)** until you reach the 7 main menus. Then press the **Battery Type/Memory Button** until you reach the PROGRAM SELECT NiCd BATT screen. Press the **Select/Start Button (K)** to enter this menu. Press the **Down (-) Button (I)** or **Up (+) Button (J)** to reach the NiCd CHARGE screen and set charging parameters. The charging amperage (A) can be set between 0.1 and 6.0A.

NiCd CHARGE Man  
CURRENT 0.1A

To select values other than the existing parameters:

- Press the **Select/Start Button** so the discharge current value (A) flashes
- Press the **Down (-) Button** or **Up (+) Button** to DECREASE or INCREASE the discharge current value
- Press the **Select/Start Button** again to save the value and the voltage value (B) flashes
- Press the **Down (-) Button** or **Up (+) Button** to DECREASE or INCREASE the voltage
- Press the **Select/Start Button** again to save the voltage value

If no parameters are flashing, you can press the **Down (-) Button** or **Increase Button** to select another program such as CHARGE or CYCLE.

To start discharging, press and hold the **Select/Start Button** for 3 seconds.

To select values other than the existing parameters:

- Press the **Select/Start Button** so the cycle type (A) flashes
- Press the **Down (-) Button** or **Up (+) Button** to set the cycle type as CHG>DCHG or DCHG>CHG
- Press the **Select/Start Button** again to save your choice and the number of cycles (B) flashes
- Press the **Down (-) Button** or **Up (+) Button** to DECREASE or INCREASE the cycle count between 1 and 5
- Press the **Select/Start Button** again to save the cycle count value

If no parameters are flashing, you can press the **Down (-) Button** or **Increase Button** to select another program such as CHARGE or DISCHARGE.

To start cycling, press and hold the **Select/Start Button** for 3 seconds.

## 18 PB DISCHARGING

A battery pack's capacity can be verified by discharging the pack to its minimum voltage level and measuring the current as the pack is discharged.

Press the **Battery Type/Memory Button (H)** until you reach the 7 main menus. Then press the **Battery Type/Memory Button** until you reach the PROGRAM SELECT Pb BATT screen. Press the **Select/Start Button (K)** to enter this menu.

Press the **Down (-) Button (I)** or **Up (+) Button (J)** to reach the Pb DISCHARGE screen and set discharging parameters. The discharging amperage (A) can be set between 0.1 and 2.0A. Voltage (C) is dependent on the number of cells in series (B) and can be set between 2.0 (for 1P batteries) to 20.0V (for 10P batteries).

Pb DISCHARGE  
A 0.1A B 2.0V(1P) B

If no parameters are flashing, you can press the **Down (-) Button** or **Increase Button** to select another program such as CHARGE.

To start discharging, press and hold the **Select/Start Button** for 3 seconds.

## 19 SAVE DATA

PROGRAM SELECT  
SAVE DATA

Press the **Battery Type/Memory Button (H)** to change among the 7 main menu screens and go to the PROGRAM SELECT SAVE DATA screen. Use this menu to save a battery profile. To reduce the time required to initiate a charging or discharging cycle on a battery you regularly use, this charger has been designed with the capability of storing up to 5 battery profiles that can be quickly accessed and run using the Load Data menu.

A  
SAVE [01] Pb  
D 2.0V 5000MAH C

- Press the **Select/Start Button (K)** to enter this menu
- Press the **Down (-) Button (I)** or **Up (+) Button (J)** to select a battery profile (A) (1 through 5)
- Press the **Select/Start Button** to save the battery profile value so the battery type (B) flashes
- Press the **Down (-) Button** or **Up (+) Button** to select a battery type
- Press the **Select/Start Button** to save the battery type and the voltage value (D) flashes
- Press the **Down (-) Button** or **Up (+) Button** to DECREASE or INCREASE the voltage

## 20 LOAD DATA

PROGRAM SELECT  
LOAD DATA

Press the **Battery Type/Memory Button (H)** to change among the 7 main menu screens and go to the PROGRAM SELECT LOAD DATA screen. Use this menu to load a saved battery profile.

A  
LOAD [01] LiPo  
11.1V 5000MAH

## 21 PROGRAM SELECT USER SET

Press the **Battery Type/Memory Button (H)** to change among the 7 main menu screens and go to the USER SET PROGRAM-> screen. Use this menu to set up programming as desired for charging your batteries. USER SET programming lets you change from default settings for "behind the scenes" operating parameters for this charger.

At the USER SET PROGRAM-> screen, press the **Select/Start Button (K)** to enter the menu. Press the **Down (-) Button (I)** or **Up (+) Button (J)** to change between sub-menu screens. Press the **Battery Type/Memory Button** to return to the main menu screen.

### a LITHIUM BATTERY TYPE

Use this menu to choose lithium battery type: Li-Po, Li-Io or Li-Fe, which shows on other Lithium battery screens.

A  
LiPo  
Li Type 3.7V

- Press the **Select/Start Button** so the voltage value (A) flashes
- Press the **Down (-) Button** or **Up (+) Button** to change the voltage value (charging voltage) value changes lithium battery type): 3.7V for Li-Po, 3.6V for Li-Ion and 3.3V for Li-Fe
- Press the **Select/Start Button** to save your selection

### c NI-MH SENSITIVITY (PEAK VOLTAGE)

NiMH Sensitivity  
D.Peak Default

Use this menu to adjust the peak voltage level (D.Peak) at which charging stops for a Ni-MH battery pack. The D.Peak value is adjustable between 5mV/Cell and 20mV/Cell. Generally, 10mV/Cell is a good choice for Ni-Cd batteries. When this value is set too high, the battery may be over-charged. When this value is set too low, the charger will not charge a battery to full capacity.

To select a value other than the default parameter:

- Press the **Select/Start Button** so the D.Peak value (A) flashes
- Press the **Down (-) Button** or **Up (+) Button** to DECREASE or INCREASE the D.peak value
- Press the **Select/Start Button** again to save this value

### e BATTERY CUTOFF TEMPERATURE

Temp Select  
Temp Cut-Off 80C

Use this menu to set a cutoff temperature that can prevent damage to the battery by stopping the charging process if the battery temperature reaches that limit. The charger can be used in conjunction with a battery mounted temperature sensor (gold separately, DYN5033) connected to the **Temperature Sensor Port (D)** to monitor the temperature of the battery during the charging process. The temperature can be set between 20~80° C (68~176° F).

To select a value other than the default parameter:

- Press the **Select/Start Button (K)** so the temperature value (A) flashes
- Press the **Down (-) Button** or **Up (+) Button** to DECREASE or INCREASE the temperature value
- Press the **Select/Start Button** again to save this value

To select values other than the existing parameters:

- Press the **Select/Start Button** so the discharge current value (A) flashes
- Press the **Down (-) Button** or **Up (+) Button** to DECREASE or INCREASE the discharge current value
- Press the **Select/Start Button** again to save the value and the voltage value (C) flashes
- Press the **Down (-) Button** or **Up (+) Button** to DECREASE or INCREASE the voltage (and # of cells in series (B))
- Press the **Select/Start Button** again to save the voltage value

If no parameters are flashing, you can press the **Down (-) Button** or **Increase Button** to select another program such as CHARGE.

To start discharging, press and hold the **Select/Start Button** for 3 seconds.

- Press the **Select/Start Button** to save the value and the battery capacity (C) flashes
- Press the **Down (-) Button** or **Up (+) Button** to DECREASE or INCREASE the battery capacity

- Press the **Select/Start Button** to save the value and the battery profile value flashes
- Press and hold the **Select/Start Button** for 3 seconds until the screen changes to the CHARGE menu
- Press the **Select/Start Button** to set the CHARGE parameters. Refer to the battery type parameter setting instructions
- Press the **Down (-) Button** or **Up (+) Button** to go to and set other parameters (BALANCE CHARGE, DISCHARGE, etc.)

After setting all parameters, press and hold the **Select/Start Button** for 3 seconds until the screen changes.

SAVE...

After the battery profile has been saved, the charger will return to the PROGRAM SELECT SAVE DATA screen.

Enter the Save Data menu and create more battery profiles or press the **Battery Type/Memory Button** to go to other options.

- Press the **Select/Start Button (K)** and the battery profile value (A) flashes
- Press the **Down (-) Button (I)** or **Up (+) Button (J)** to DECREASE or INCREASE the battery profile value

- Press and hold the **Select/Start Button** until the battery charging function screen shows
- Press the **Down (-) Button** or **Up (+) Button** to go to the charging function you need

- Press and hold the **Select/Start Button** to start the chosen charging function

## g SAFETY TIMER

Safety Timer  
ON 180min

Use this menu to set a time limit for charging a battery. When a charge cycle is started, a clock inside the charger will begin recording the elapsed charge time. If the safety timer function has been turned ON, the charger will stop the charging process once this time limit has been reached to avoid damage caused by over-charging the battery. This time value can be set between 10 and 720 minutes.

To select values other than the default parameters:

- Press the **Select/Start Button** so ON or OFF (A) flashes
- Press the **Down (-) Button** or **Up (+) Button** to turn the safety timer ON or OFF
- Press the **Select/Start Button** again to save this setting and the capacity value (B) flashes
- Press the **Down (-) Button** or **Up (+) Button** to DECREASE or INCREASE the time value
- Press the **Select/Start Button** again to save this value

## i BEEP AND BUZZER SOUND CONTROL

Key Beep ON  
Buzzer ON

Use this menu to set the key beep and charger alarm buzzer at ON or OFF as needed. We recommend that you keep the alarm ON so the alarm will sound when charging is complete or if there is cause for alarm during charging.

To select values other than the default parameters:

- Press the **Select/Start Button** so ON or OFF (A) flashes
- Press the **Down (-) Button** or **Up (+) Button** to set the key beep at ON or OFF
- Press the **Select/Start Button** again to save this setting and ON or OFF (B) flashes
- Press the **Down (-) Button** or **Up (+) Button** to set the buzzer at ON or OFF
- Press the **Select/Start Button** again to save this value

## 22 USB DEVICE CHARGING

The charger has the capability to charge a smartphone, music player or any USB-compatible device with the **2.1A USB Power Output Port (E)**. To use the charging function, simply connect a compatible charging device or cord into the charge port while the charger is powered ON. The charger provides up to 2.1A current at 5V DC.

## 23 TROUBLESHOOTING

LCD Screen Warning and Error messages shown below. During charger operation, circuits monitor battery and charger functions. If the following messages show on the charger's LCD screen, make the recommended responses. If the message continues after you respond as recommended, contact your nearest Horizon Hobby customer service center for assistance.

REVERSE POLARITY	Make sure each connection polarity is correct between the power source and the charger, then between the charger and the battery
CONNECTION BREAK	Make sure the power connections are correct for charging
SHORT ERR	Make sure there are no short circuits between the poles of the battery or the battery and the charger. Replace damaged wires.
INPUT VOL ERR	Input voltage to the charger fell below the default or adjusted input voltage setting. Make sure the power source for the charger provides correct input voltage.
VOL SELECT ERR	Incorrect setting for cell in series count (pack voltage) of a lithium battery. Make charger settings match the battery pack label cell in series count specifications or replace the battery.
BREAK DOWN	Charger electronics require repair.
BATTERY CHECK LOW VOLTAGE	Battery voltage is lower than the value setting in the charger. Adjust settings, then make sure the battery is not damaged or replace the battery.
BATTERY CHECK HIGH VOLTAGE	Battery voltage is higher than the value setting in the charger. Adjust settings, then make sure the battery is not damaged or replace the battery.

Battery type	Li-Po	Li-Io	Li-Fe	Ni-MH	Ni-Cd	Pb
Standard voltage (Volts per cell)	3.70	3.60	3.30	1.20	1.20	2.00
Max. voltage (Volts per cell)	4.20	4.10	3.60	1.60	1.60	2.45
Min. voltage (Volts per cell)	3.00	3.00	2.60	1.00	0.85	1.75

## h BATTERY CAPACITY CUTOFF

Capacity Cut-Off  
ON 5000mAh

Use this menu to set a capacity limit on when the charger stops charging a battery. When a charge cycle starts, the charger records the battery capacity. When the capacity cutoff function is set ON, the charger will stop charging at the capacity limit to prevent battery damage. Capacity can be adjusted between 10 and 50,000mAh.

To select values other than the default parameters:

- Press the **Select/Start Button** so ON or OFF (A) flashes
- Press the **Down (-) Button** or **Up (+) Button** to turn the capacity cutoff ON or OFF
- Press the **Select/Start Button** again to save this setting and the capacity value (B) flashes
- Press the **Down (-) Button** or **Up (+) Button** to DECREASE or INCREASE capacity value
- Press the **Select/Start Button** again to save this value

## j INPUT POWER LOW VOLTAGE CUTOFF

Input Power Low  
Cut-Off 11.0V

Use this menu to set the input voltage limit so an alarm will sound if the voltage goes below the cutoff value. The voltage alarm value can be set from 10.0 to 11.0V.

To select a value other than the default parameter:

- Press the **Select/Start Button** so the voltage value (A) flashes
- Press the **Down (-) Button** or **Up (+) Button** to DECREASE or INCREASE the voltage value
- Press the **Select/Start Button** again to save this value

## NON-UNITED STATES

**What this Warranty Covers** - Horizon Hobby, LLC ("Horizon") warrants to the original purchaser that the product purchased (the "Product") will be free from defects in materials and workmanship at the date of purchase.

**What is Not Covered** - This warranty is not transferable and does not cover (i) cosmetic damage, (ii) damage due to acts of God, accident, misuse, abuse, negligence, commercial use, or due to improper use, installation, operation or maintenance, (iii) modification of or to any part of the Product, (iv) attempted service by anyone other than a Horizon Hobby authorized service center, (v) Product not purchased from an authorized Horizon dealer, or (vi) Product not compliant with applicable technical regulations.

OTHER THAN THE EXPRESS WARRANTY ABOVE, HORIZON MAKES NO OTHER WARRANTY OR REPRESENTATION, AND HEREBY DISCLAIMS ANY AND ALL IMPLIED WARRANTIES, INCLUDING, WITHOUT LIMITATION, THE IMPLIED WARRANTIES OF NON-INFRINGEMENT, MERCHANTABILITY AND FITNESS FOR A PARTICULAR PURPOSE. THE PURCHASER ACKNOWLEDGES THAT THEY ALONE HAVE DETERMINED THAT THE PRODUCT WILL SUITABLY MEET THE REQUIREMENTS OF THE PURCHASER'S INTENDED USE.

**Purchaser's Remedy** - Horizon's sole obligation and purchaser's sole and exclusive remedy shall be that Horizon will, at its option, either (i) service, or (ii) replace, any Product determined by Horizon to be defective. Horizon reserves the right to inspect any and all Product(s) involved in a warranty claim. Service or replacement decisions are at the sole discretion of Horizon. Proof of purchase is required for all warranty claims.

**Service or Replacement as Provided Under this Warranty is the Purchaser's Sole and Exclusive Remedy** - For Warranty consideration, you must include your **Limitation of Liability** - HORIZON SHALL NOT BE LIABLE FOR SPECIAL, INDIRECT, INCIDENTAL OR CONSEQUENTIAL DAMAGES, LOSS OF PROFITS OR PRODUCTION OR COMMERCIAL LOSS IN ANY WAY, REGARDLESS OF WHETHER SUCH CLAIM IS BASED IN CONTRACT, WARRANTY, TORT, NEGLIGENCE, STRICT LIABILITY OR ANY OTHER THEORY OF LIABILITY, EVEN IF HORIZON HAS BEEN ADVISED OF THE POSSIBILITY OF SUCH DAMAGES. Further, in no event shall the liability of Horizon exceed the individual price of the Product on which liability is asserted. As Horizon has no control over use, setup, final assembly, modification or misuse, no liability shall be assumed nor accepted for any resulting damage or injury. By the act of use, setup or assembly, the user accepts all resulting liability. If you as the purchaser or user are not prepared to accept the liability associated with the use of the Product, purchaser is advised to return the Product immediately in new and unused condition to the place of purchase.

**Law** - These terms are governed by Illinois law (without regard to conflict of law principles). This warranty gives you specific legal rights, and you may also have other rights which vary from state to state. Horizon reserves the right to change or modify this warranty at any time without notice.

## WARRANTY SERVICES

**Questions, Assistance, and Services** - Your local hobby store and/or place of purchase cannot provide warranty support or service. Once assembly, setup or use of the Product has been started, you must contact your local distributor or Horizon directly. This will enable Horizon to better answer your questions and service you in the event

WARRANTY AND SERVICE CONTACT INFORMATION			
Country of Purchase	Horizon Hobby	Contact Information	Address
United States of America	Horizon Service Center (Repairs and Repair Requests)	servicecenter.horizonhobby.com/RequestForm/	4105 Fieldstone Rd Champaign, Illinois, 61822 USA
	Horizon Product Support (Product Technical Assistance)	www.quickbase.com/db/bghj7ey8c7a=GenNewRecord	
	Sales	sales@horizonhobby.com 888-959-2306	
United Kingdom	Service/Parts/Sales: Horizon Hobby Limited	sales@horizonhobby.co.uk +44 (0) 1279 641 097	Units 1-4, Plythers Rd, Staple Tye Harlow, Essex, CM18 7NS, United Kingdom
Germany	Horizon Technischer Service Sales: Horizon Hobby GmbH	service@horizonhobby.de +49 (0) 4121 2655 100	Christian-Junge-Straße 1 25337 Elmshorn, Germany
France	Service/Parts/Sales: Horizon Hobby SAS	infofrance@horizonhobby.com +33 (0) 1 60 18 34 90	11 Rue Georges Charpak 77127 Lieusaint, France
China	Service/Parts/Sales: Horizon Hobby - China	info@horizonhobby.com.cn +86 (021) 5180 9668	Room 506, No. 97 Changshou Rd. Shanghai, China 200060

## FCC INFORMATION

Note: This equipment has been tested and found to comply with the limits for a Class B digital device, pursuant to Part 15 of the FCC rules. These limits are designed to provide reasonable protection against harmful interference in a residential installation. This equipment generates, uses and can radiate radio frequency energy and, if not installed and used in accordance with the instructions, may cause harmful interference to radio communications.

## DECLARATION OF CONFORMITY (in accordance with ISO/IEC 17050-1)

No. HH2013091205

Product(s): DYN Prophet Precept 80W LCD AC/DC Battery Charger

Item Number(s): DYNC2015EU, DYNC2015LK

The object of declaration described above is in conformity with the requirements of the specifications listed below, following the provisions of the EMC Directive 2004/109/EC and LVD Directive 2006/95/EC:

EN5022:2010 + AC:2011

EN5024:2010

EN61000-3-2:2006+A1:2009+A2:2009

EN61000-3-3:2008

EN60335-1: 2002+A11:2004+A1:2004+A12:2006+A2:2006+A13:2008+A14:2010+A15:2011

EN60335-2-29:2004+A2:2010

Signed for and on behalf of:

Horizon Hobby, LLC  
Champaign, IL, USA

September 12, 2013

**Instructions for disposal of WEEE by users in the European Union**